



Additional Information

Assembly required - yes
 Electrical required - no
 Plumbing required - yes
 Wall blocking required - yes
 COM yardage/laminate usage - 178 sf
 4" h laminated plywood toe + 1/4" h glides
 Other (specify) - n/a
 Other (specify) - n/a

Specification Drawing

This **Specification Drawing** is intended for communicating the basic description, function, appearance, dimensions, features, and installation of an item as manufactured by Collins Manufacturing Company. Because this drawing does not contain project specific information such as quantities, finishes, or options, it is not an approval drawing and does not require a signature. This drawing remains the property of Collins Manufacturing Company and must not be used against the interests of Collins Manufacturing Company.

Product Information

		Collins Manufacturing 2000 Bowser Road Cookeville, TN 38506	
Name:			
10 Foot Organizer			
Size:	Part Number:	Drawn By:	
NTS	2660-120	Eng	
Prepared Date:	Revision Date:	Revision Number:	Sheet:
5/29/20	Date	Rev #	1 of 4

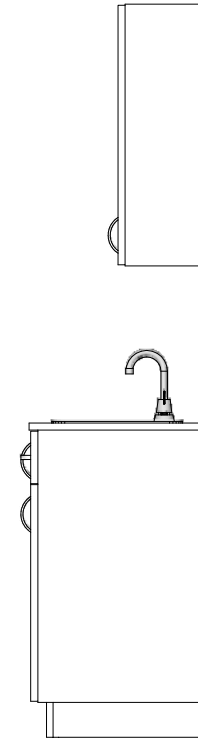
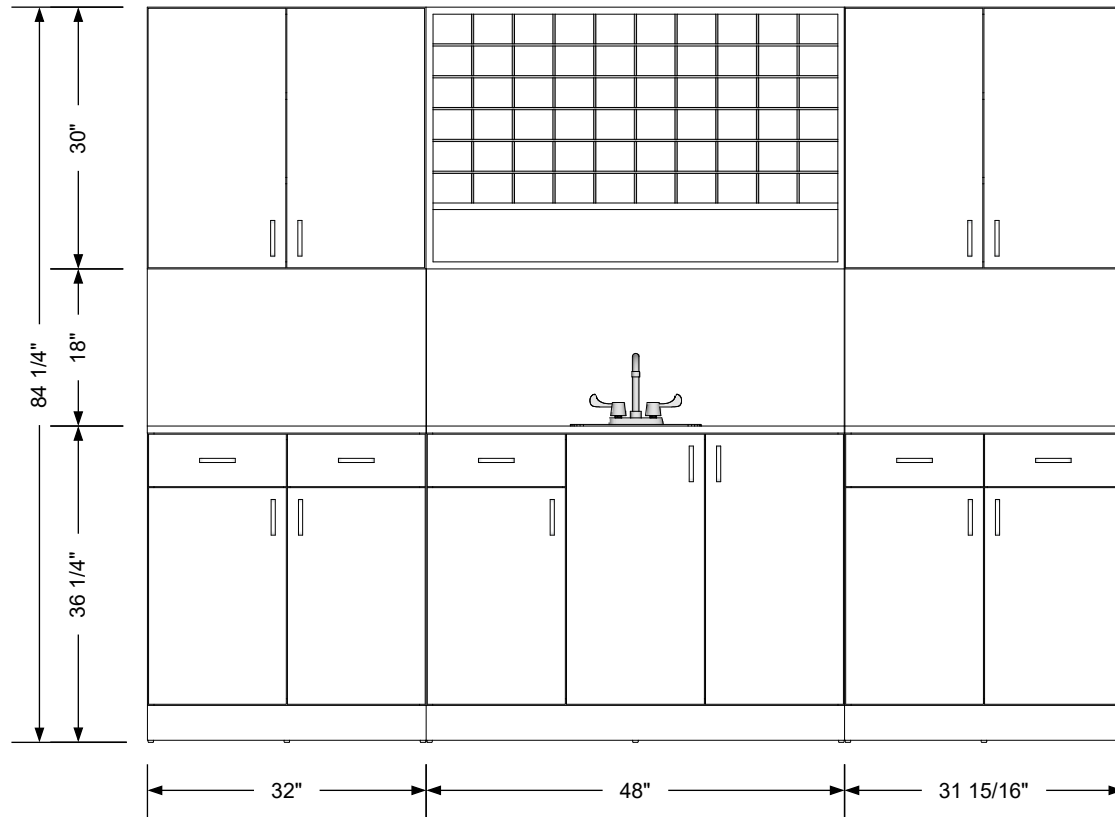
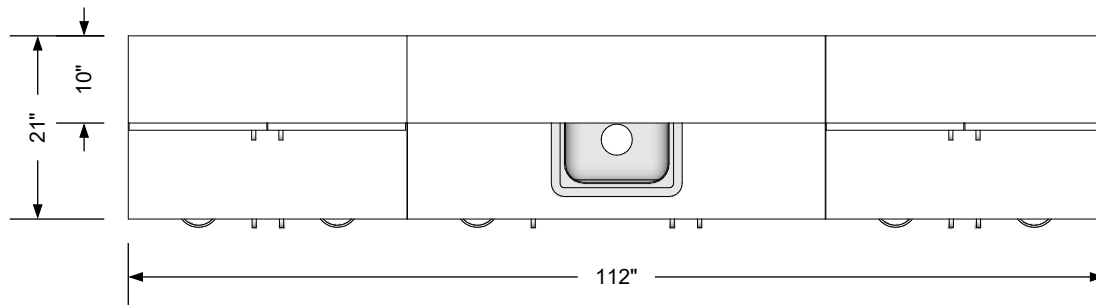

Additional Information

Assembly required - yes
 Electrical required - no
 Plumbing required - yes
 Wall blocking required - yes
 COM yardage/laminate usage - 178 sf
 4"h laminated plywood toe + 1/4"h glides
 Other (specify) - n/a
 Other (specify) - n/a

Specification Drawing

This **Specification Drawing** is intended for communicating the basic description, function, appearance, dimensions, features, and installation of an item as manufactured by Collins Manufacturing Company. Because this drawing does not contain project specific information such as quantities, finishes, or options, it is not an approval drawing and does not require a signature. This drawing remains the property of Collins Manufacturing Company and must not be used against the interests of Collins Manufacturing Company.

Product Information

		Collins Manufacturing 2000 Bowser Road Cookeville, TN 38506	
Name: 10 Foot Organizer			
Size: NTS	Part Number: 2660-120	Drawn By: Eng	
Prepared Date: 5/29/20	Revision Date: Date	Revision Number: Rev #	Sheet: 2 of 4

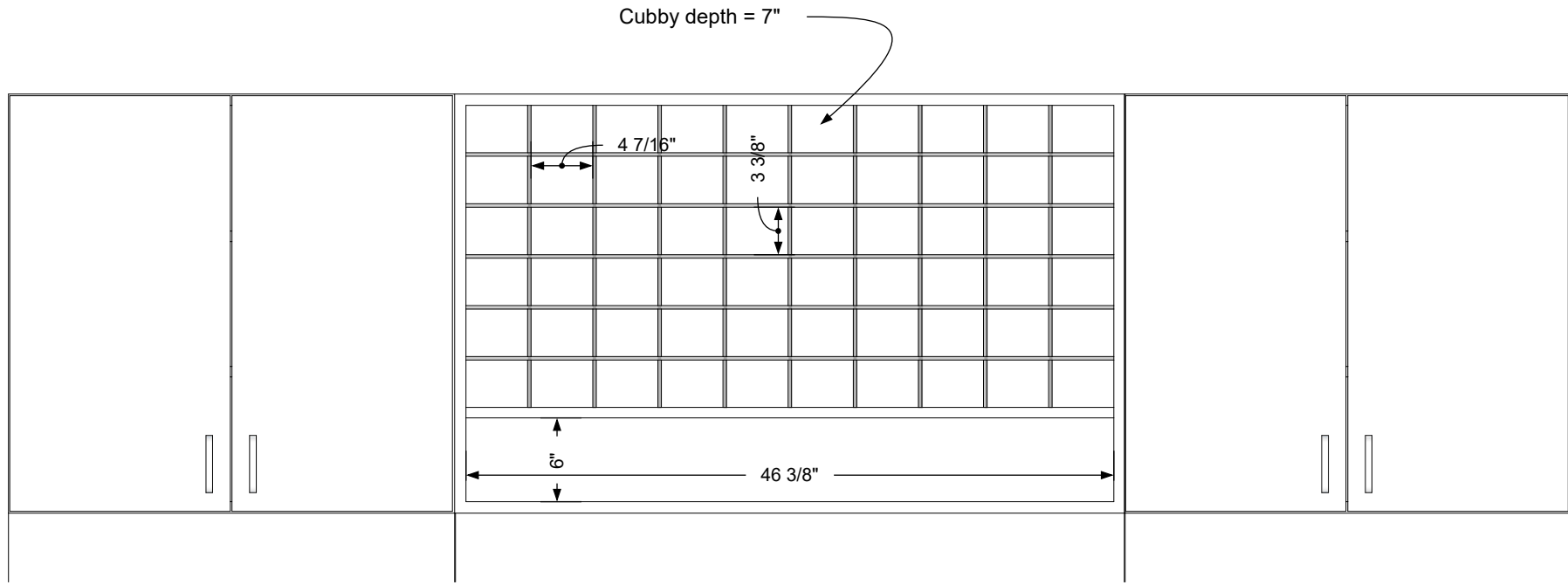

Cubby details

Additional Information

Assembly required - yes
 Electrical required - no
 Plumbing required - yes
 Wall blocking required - yes
 COM yardage/laminate usage - 178 sf
 4" h laminated plywood toe + 1/4" h glides
 Other (specify) - n/a
 Other (specify) - n/a

Specification Drawing

This **Specification Drawing** is intended for communicating the basic description, function, appearance, dimensions, features, and installation of an item as manufactured by Collins Manufacturing Company. Because this drawing does not contain project specific information such as quantities, finishes, or options, it is not an approval drawing and does not require a signature. This drawing remains the property of Collins Manufacturing Company and must not be used against the interests of Collins Manufacturing Company.

Product Information

		Collins Manufacturing 2000 Bowser Road Cookeville, TN 38506	
Name: 10 Foot Organizer			
Size: NTS	Part Number: 2660-120	Drawn By: Eng	
Prepared Date: 5/29/20	Revision Date: Date	Revision Number: Rev #	Sheet: 3 of 4

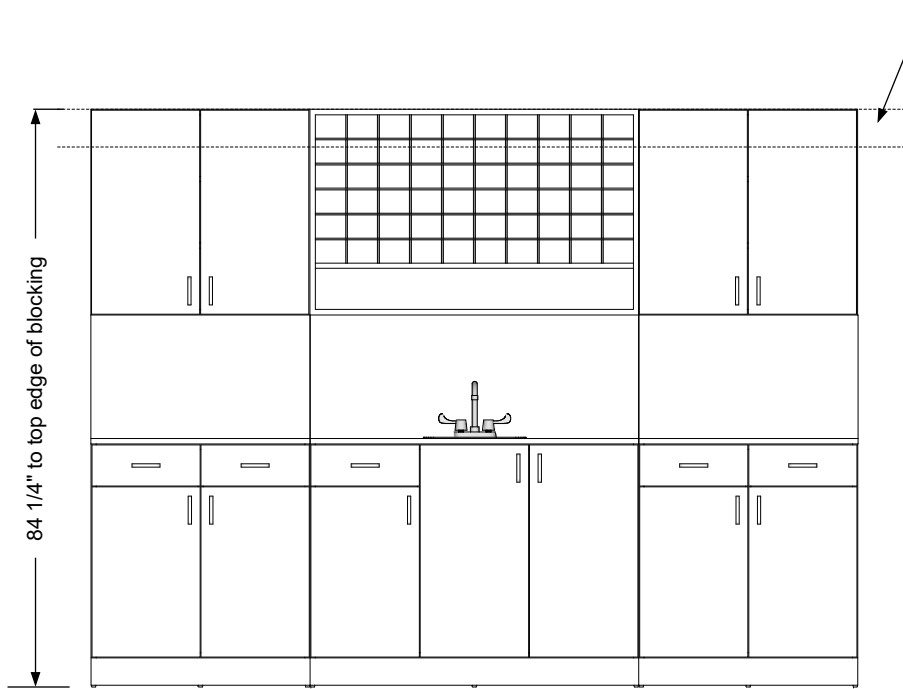

Blocking detail

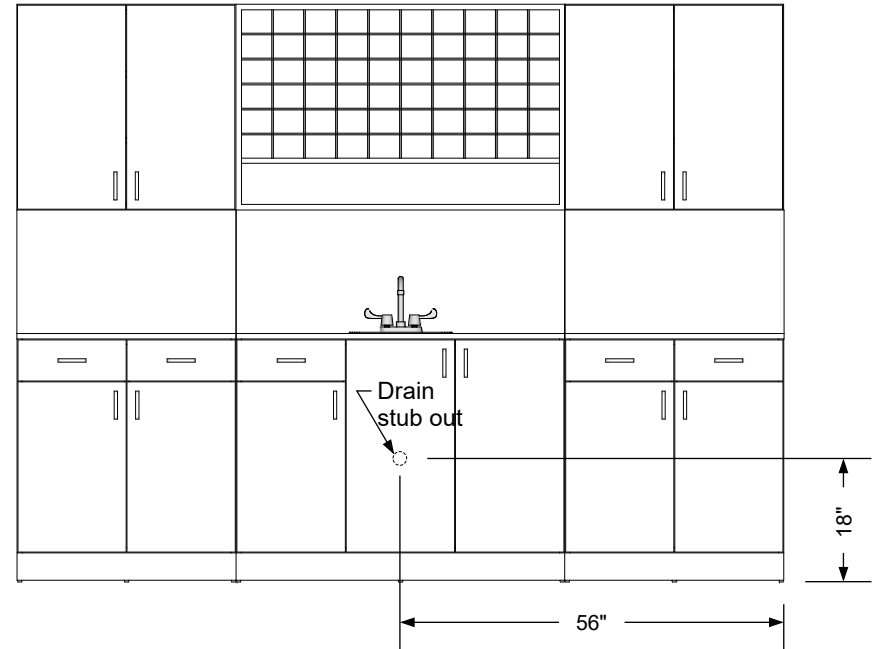

Plumbing stub out detail

Additional Information

Assembly required - yes
 Electrical required - no
 Plumbing required - yes
 Wall blocking required - yes
 COM yardage/laminate usage - 178 sf
 4"h laminated plywood toe + 1/4"h glides
 Other (specify) - n/a
 Other (specify) - n/a

Specification Drawing

This **Specification Drawing** is intended for communicating the basic description, function, appearance, dimensions, features, and installation of an item as manufactured by Collins Manufacturing Company. Because this drawing does not contain project specific information such as quantities, finishes, or options, it is not an approval drawing and does not require a signature. This drawing remains the property of Collins Manufacturing Company and must not be used against the interests of Collins Manufacturing Company.

Product Information

		Collins Manufacturing 2000 Bowser Road Cookeville, TN 38506	
Name: 10 Foot Organizer			
Size: NTS	Part Number: 2660-120	Drawn By: Eng	
Prepared Date: 5/29/20	Revision Date: Date	Revision Number: Rev #	Sheet: 4 of 4